

---

# SOLVE HEAT TRANSFER CHALLENGES QUICKLY AND COST-EFFECTIVELY WITH FLOW SIMULATION

---

## OVERVIEW

Finding effective solutions to heat transfer problems has become an increasingly important part of new product development. Almost everything experiences heating or cooling of some kind, and for many products, such as modern electronics, medical devices, and HVAC systems, managing heat is a critical requirement for avoiding overheating and achieving functional success. Manufacturers who can efficiently resolve heat transfer issues will have a distinct competitive advantage. With an easy-to-use, fluid-flow analysis application like SolidWorks® Flow Simulation software, you will have the tools that you need to solve even the most difficult heat transfer problems, while saving time and money in the process.

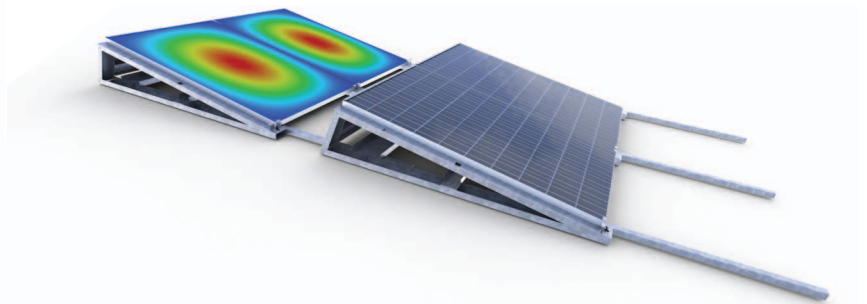
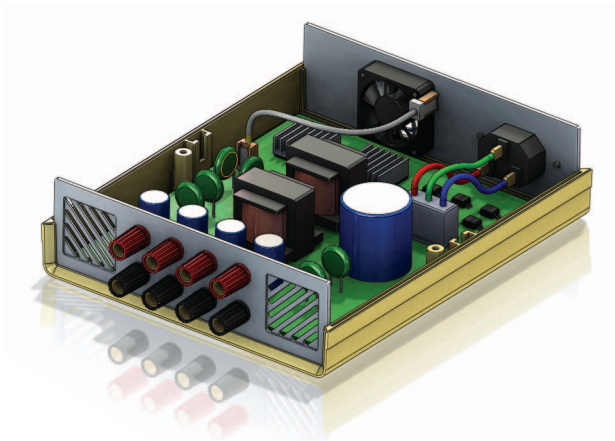

## Heat transfer is everywhere

The effects of temperature on a product's performance have always been important design considerations, whether the product is subjected to environmental heating/cooling or generates its own rise or drop in temperature. What's changing today is that the number of heat transfer problems that product developers face is growing and the complexity of those challenges is increasing, especially for manufacturers of certain types of products, such as handheld electronics; medical devices; and sophisticated heating, ventilation, and air conditioning (HVAC) systems.



In the development of medical devices, engineers need to create innovative designs that often rely on the use of flow simulation for evaluating the thermal performance characteristics of new concepts.

The traditional approach to thermal management was to test physical prototypes and attempt to measure the effects of temperature changes and the transfer of heat from one component to another. In addition to being time-consuming and costly, using physical prototypes to resolve heat transfer issues can be exceedingly difficult and often impossible, due to the obstacles associated with miniaturization and placing sensors inside closed systems. To compensate for a lack of knowledge about what's really going on inside a design in terms of heat transfer, many engineers simply overdesign a product in an effort to make heat transfer issues moot.

However, in the current global economy, overdesigning to hedge against possible heat transfer problems can reduce your competitiveness as much as underdesigning can lead to overheating and product failure. In today's competitive environment, manufacturers simply cannot afford the time and cost associated with conventional prototyping solutions to heat transfer concerns. Furthermore, by effectively addressing and understanding heat transfer considerations early in the design process, you can save time, minimize prototyping costs, ensure quality, and introduce the innovations that are vital to your company's success. Computational fluid dynamics (CFD) analysis software can help you do just that.



To address the trend towards miniaturization, designers of electronics products need to resolve multiple heat transfer challenges, for which they can use flow simulation.

## Flow simulation—it's not just for aerodynamics

Many engineers think of CFD analysis applications, also known as flow simulation, as virtual wind tunnels. They believe their primary use is to reduce drag by improving the aerodynamics of vehicle designs. Even though flow simulation has its roots in aerodynamic design, the technology has even greater potential for resolving heat transfer problems.

A new generation of CFD tools is now available for tackling heat transfer challenges. With these tools, you're not looking to reduce drag in order to make something go faster, you're trying to maximize cooling by optimizing fluid flow in order to ensure that your products perform safely and reliably with no ill thermal effects. The same technology that can simulate airflow around a car body or fuselage can simulate airflows inside your product housing and assess how such flows influence the temperature and performance of critical components.

The use of heat sinks for thermal management can only address certain situations. Many manufacturers are looking to use additional flow-based cooling methods, such as cooling methods. Heat pipes, for example, combine thermal conductivity with evaporation-condensation phase transition to transfer heat, and thermoelectric coolers (TECs), which use electric current to transfer heat, to ensure adequate component cooling.

Flow simulation lets you examine how well these diverse approaches to managing heat will actually work before you build anything. While designing your product, you can compare temperature distribution, heat flux, and air circulation. With this type of insight and knowledge, you will be able to analyze innovative new concepts more cost-effectively. It doesn't matter if you're designing hi-tech electronic gadgets, consumer products, medical devices, HVAC systems, or industrial heaters/coolers. With flow simulation software, you will gain a greater understanding and come up with better solutions to your heat transfer problems.

*"WITH SOLIDWORKS (FLOW SIMULATION), OUR DESIGNERS ARE ABLE TO SIMULATE THE PHYSICS AT WORK DURING COMPONENT AND SYSTEM DESIGN, WHICH RESULTS IN PRODUCT INNOVATIONS THAT ARE MORE FULLY DEVELOPED WHEN FINAL VALIDATION OCCURS."*

**Anthony Macaluso**  
MANAGER OF PRODUCT DESIGN  
NUVERA FUEL CELLS, INC.



### Case in Point: Nuvera Fuel Cells

Hydrogen is the most abundant element in the universe, and Nuvera Fuel Cells, Inc., is working to make it the clean, safe, and efficient energy source of tomorrow. As a global leader in the development of fuel cell systems and processors, the company is on the forefront of research and development—with active commercial applications—toward tapping the incredible potential of hydrogen power.

Nuvera heavily relied on SolidWorks Flow Simulation software to fast-track development of the company's fuel cell and hydrogen generation systems. The company's designers used the software to conduct preliminary flow analyses of water and gas flows.

"The water-gas conversion process represents the crux of our technology," explains Anthony

Macaluso, manager of product design. "Making that conversion as efficient as possible—whether it is within the fuel cell stack or our hydrogen generator—is our primary challenge. With SolidWorks (Flow) Simulation, our designers are able to simulate the physics at work during component and system design, which results in product innovations that are more fully developed when final validation occurs."

By selecting SolidWorks solutions, including SolidWorks Flow Simulation software, Nuvera shortened its design cycles by 25 percent, cut development costs by 33 percent, reduced costs related to scrap and rework by 20 percent, and secured a significant share of the forklift truck fuel cell market.

## Getting the heat out of electronics

More and more product designs require the use of printed circuit boards (PCBs) and electronic components. From computers, smart phones, and tablets to gaming consoles, MP3 players, and medical devices, many new products rely on electronics to fulfill their functions. PCBs and electronic components generate heat. Managing this heat—either by transporting it away from sensitive areas or by using fluid flows to cool critical components—is necessary for the successful development of electronics-based products.

Analyzing the rate of cooling of electronic components inside of a mechanical housing is incredibly important but nearly impossible with physical prototyping, especially when you consider the trend toward miniaturization. As these products get smaller and smaller—the iPod® has gone from the size of a deck of playing cards to the size of a matchbook—assessing heat transfer behavior not only becomes more difficult but also more essential for gaining insight into cooling performance. There are no sensors small enough to gather this information. The only way that you can accurately determine whether cooling systems in small, enclosed electronics will be adequate or lead to overheating is to use flow simulation.

With flow simulation capabilities, you can do much more than just assess the existing state of your design's performance relative to heat transfer. You can use the results to optimize, size, and reconfigure cooling components (e.g., fans, heat sinks) to improve cooling performance.

Should I use a heat pipe to carry heat away from this area? What size heat pipe will I need? Will a TEC meet my needs for this design? Are there alternative materials that I can use to improve the performance of my heat sinks? These are the types of questions for which flow simulation, or coupled flow-thermal analysis, can provide accurate, reliable answers.

*"SOLIDWORKS FLOW SIMULATION NOT ONLY IMPROVES OUR PRODUCTIVITY AND EFFICIENCY, BUT ALSO LETS US TACKLE HEAT TRANSFER CHALLENGES THAT WE WOULD NOT BE ABLE TO RESOLVE WITHOUT IT."*

**Bernd Knab**  
DEVELOPMENT MANAGER  
POLYRACK TECH-GROUP

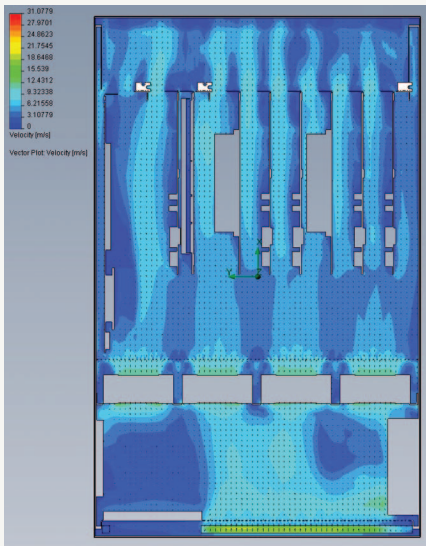

### Case in Point: POLYRACK Tech-Group

Effective packaging of racked electronic systems involving multiple PCBs and complex heat transfer challenges demands the expertise of a company like the POLYRACK Tech-Group. The German manufacturer is a leading provider of integrated packaging solutions for the electronics industry.

With SolidWorks Flow Simulation, POLYRACK can quickly simulate heat transfer behavior in packaging designs, 90 percent of which are customized for specific applications. These insights enable POLYRACK engineers to improve cooling performance while simultaneously saving time and reducing costs. For example, on a housing that included 10 different motherboards, flow simulations demonstrated that the use of eight small fans cooled the system more effectively than the four large fans initially used in the design.

"The key is achieving the ideal amount of airflow over electronic components," says Development

Manager Bernd Knab. "With racked systems, you often have situations in which the board that is positioned near the fan receives most of the airflow, while the next board down in the rack isn't getting enough. With SolidWorks Flow Simulation, we were able to see that by placing perforated metal plates in front of the fans and repositioning the PCBs, we could disperse the flow and provide homogeneous airflow throughout the system.... In addition to optimizing the cooling system, SolidWorks Flow Simulation helps us cut an average of two prototypes from each project."

By selecting SolidWorks Flow Simulation software and its Electronics Cooling Module, POLYRACK reduced its development time from three months to two weeks, cut two prototyping cycles, generated new flow simulation consulting business, and innovated effective approaches to electronics cooling system design.

## Optimizing HVAC systems

The HVAC industry has traditionally used rough formulas and load estimates to size the capacity of its systems to meet specific building needs. In an effort to make sure that HVAC units do not underperform, these estimates have inclined toward overcapacity. In other words, HVAC systems have not tended to be exactly sized, and the industry has favored overcapacity to ensure adequate performance as being more favorable than falling short.

However, at a time when energy costs are soaring—and when energy savings have become paramount, particularly for customers who want to achieve a green building designation—HVAC vendors are under pressure to get more precise in aligning their systems with specific customer needs. Building owners do not want to absorb the cost of operating a 15,000 BTU unit when a 10,000 BTU unit will do; nor does a factory want an industrial heater/cooler that's larger, and consumes more energy, than what's necessary.

HVAC companies face the quandary of needing greater accuracy in system deployment, so they can prove to customers how well a system's capacity matches a particular need, yet being unable to prototype the many potential applications for their systems. That would be cost-prohibitive and impractical in the vast majority of cases, but is where flow simulation technology can play a role.

Using CFD analysis, HVAC suppliers can cost-effectively simulate how airflow will behave for any type of building, factory, or structure, whether the application is for heating, cooling, or ventilation. In addition to being able to accurately gauge cooling capacity, and demonstrate to customers how precisely capacity tracks specific needs, HVAC companies can use flow simulation to improve system performance—calculating comfort parameters inside a specific building or environment—while bringing down costs. The result is a real competitive advantage.

*"WITH SOLIDWORKS (FLOW) SIMULATION SOFTWARE, WE WERE ABLE TO STUDY AND TEST SIX DIFFERENT CONCEPTS AND REACH AN OPTIMIZED DESIGN IN LESS THAN THREE MONTHS. WE ELIMINATED MORE THAN TWO YEARS OF COSTS, SAVED \$100,000 ON PROTOTYPING, AND PRODUCED A PATENTED IDEA FOR ENHANCING HEAT TRANSFER. THAT'S THE KIND OF ADVANTAGE THAT HELPS US BEAT OUR COMPETITION."*

**Craig Tiras, P.E.**

**VICE PRESIDENT OF ENGINEERING AND DESIGN  
GAUMER PROCESS**

### Case in Point: Gaumer Process

When companies in the process industries, including oil, gas, food-processing, wastewater treatment, and petrochemical companies, have electric process heating needs, Gaumer Process often tops their list. That's because the Houston-based manufacturer helped to develop electric process heater technology over the last 30 years, acquiring several patents for its electric process heaters, systems, and controls.

Gaumer Process uses SolidWorks Flow Simulation to improve heat transfer performance. For instance, the company's engineers believed that an internal baffle design could enhance heat transfer within its electric process heaters.

Without SolidWorks Simulation tools, Gaumer engineers most likely would have pursued a cross-baffle design—four times better, theoretically—and then would have worked through trial and error to optimize it. That process would have taken three years. However, by using SolidWorks

CFD and thermal analysis software to simulate heat transfer in a variety of concepts, Gaumer was able to show that an optimized scissor-baffle design performed best.

"With SolidWorks (Flow) Simulation software, we were able to study and test six different concepts and reach an optimized design in less than three months," says Craig Tiras, P.E., vice president of engineering and design. "We eliminated more than two years of costs, saved \$100,000 on prototyping, and produced a patented idea for enhancing heat transfer. That's the kind of advantage that helps us beat our competition."

By implementing SolidWorks Simulation tools, including SolidWorks Flow Simulation software, Gaumer Process cut its development cycle from three years to three months, saved \$100,000 in prototyping costs, reduced material costs by 75 percent, and enhanced its ability to visualize system performance.

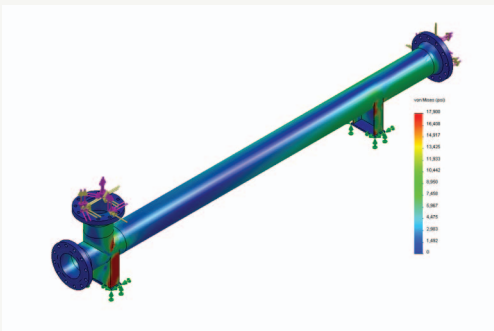



## Gaining the advantages of flow simulation

The benefits of using flow simulation technology to resolve heat transfer problems are obvious and well documented. In a 2008 study, the Aberdeen Group found that companies that leverage three or more different types of simulations reduced the number of physical prototypes that they produce by 37 percent. These findings led the Aberdeen Group to conduct a CFD analysis-specific study in 2011 to determine the impact of flow simulation. That study ("Optimizing Product Development Time by Using CFD as a Design Tool") showed that since implementing CFD in their development processes, best-in-class companies have been able to reduce development time by 28 percent, lower product costs by 24 percent, and produce 23 percent fewer physical prototypes.

These companies are able to achieve these significant productivity gains because the ability to visualize how fluid flows behave provides designers and engineers with greater insights into heat transfer problems. Specifically, understanding how fluid flows cool components and transfer heat enables you to optimize your designs for peak performance.

With increasing complexity come situations in which your design is simultaneously impacted by multiple physical forces, such as heat, stress, and friction. Understanding how these forces influence your design collectively and how fluid flow affects design response to these collective forces is not intuitive, and requires simulation applications, including flow simulation.

With flow simulation tools, you will be able to minimize expensive prototyping, shorten development cycles, and cost-effectively study innovative approaches. Competitive pressures demand that you find ways to differentiate your products. You can do this by providing higher quality and greater reliability, or introducing innovation. Flow simulation technology can help you achieve all three.

*"USING SOLIDWORKS FLOW SIMULATION SOFTWARE, WE WERE ABLE TO CHALLENGE SOME FUNDAMENTAL IDEAS ABOUT SEDIMENTATION SYSTEM DESIGN AND DRAMATICALLY BOOST PERFORMANCE, IMPROVING WATER/SLUDGE SEPARATION EFFICIENCY BY 25 PERCENT."*

**Travis Kenworthy**  
ENGINEER  
CLEARSTREAM ENVIRONMENTAL, INC.

### Fast Facts

Since implementing their current flow simulation process to assess product behavior, best-in-class companies have been able to

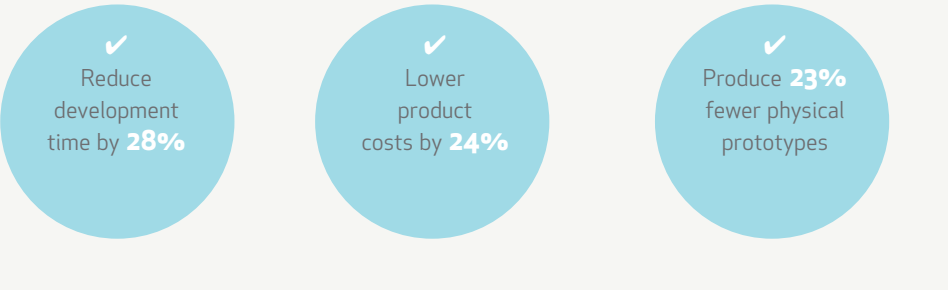

## Solve heat transfer problems with SolidWorks Flow Simulation

To realize the benefits of using flow simulation to resolve thermal issues quickly and cost-effectively, choose a CAD-integrated application like SolidWorks Flow Simulation software. Heat transfer problems can be quite complex, but the tools that you use to solve them need not be. SolidWorks Flow Simulation software operates within the SolidWorks design environment and makes CFD analysis more convenient and productive.

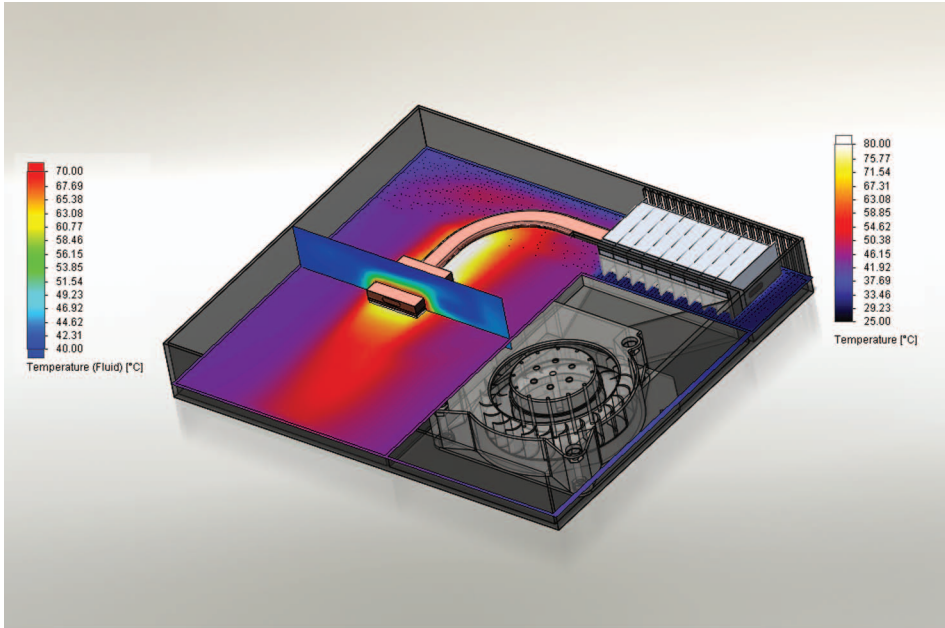

SolidWorks Flow Simulation software provides a wide range of fluid-flow and heat-transfer capabilities, which designers can use to gain greater insight into product behavior for many applications.

With SolidWorks Flow Simulation, you can simulate fluid flow, heat transfer, and fluid forces that are critical to the success of your design. You can analyze internal and external flows, run “what if” scenarios, optimize airflows, and quickly analyze the effects of fluid flow, heat transfer, and related forces on immersed or surrounding components. You will be able to identify the best dimensions or flow conditions to meet your design goals. You can even compare and assess the impact of impeller and fan motion on your flow using rotating coordinate frames.

SolidWorks Flow Simulation software allows you to simulate the full range of thermal phenomena, including convection, conduction, and radiation effects. While these tools will help you solve a wide range of heat transfer problems, two additional modules are designed to help you evaluate heat transfer related to specific types of product design. These include the Electronics Cooling Module and the HVAC Module.

*“THE COMBINATION OF OUR EXPERTISE, THE INTEGRATION OF SOLIDWORKS (FLOW) SIMULATION, AND THE SOFTWARE’S RANGE OF CAPABILITIES HAS ALLOWED US TO CUT DEVELOPMENT TIME IN HALF... WE ARE MAKING A MORE ACCURATE, HIGHER-QUALITY PRODUCT BY USING SIMULATION TO OPTIMIZE THE DESIGN, INSTEAD OF BUILDING PROTOTYPE AFTER PROTOTYPE.”*

**Carel Kriek**  
CHIEF MECHANICAL ENGINEER  
REUTECH RADAR SYSTEMS

## Specific tools for electronics cooling

As with any undertaking, having the right tools—that were designed for the specific task—can make a job faster and a whole lot easier. That's certainly the case with the SolidWorks Flow Simulation Electronics Cooling Module. This CAD-integrated software was specifically developed to help you test and optimize the thermal performance of the PCBs and electronic components included in your designs.

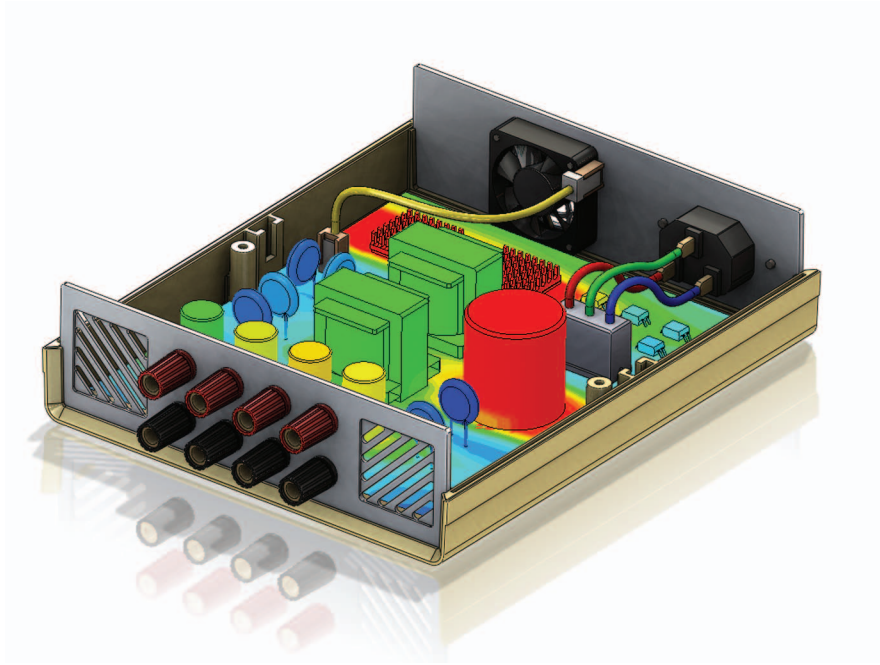

The SolidWorks Flow Simulation Electronics Cooling Module enables designers to evaluate the thermal properties of components and more accurately establish cooling requirements for PCB and enclosure designs.

With this powerful module, you will be able to more easily optimize airflow, by moving components and creating air baffles and ducts; validate overall thermal performance, by studying heat-up/cool-down cycles and maximum temperature under load; and pick the best heat sink, by assessing the impact of airflow cooling over the PCB. You can also isolate the thermal characteristics of the PCB, so you can evaluate component placement and the use of heat pipes, thermal pads, and interface materials; and select and place the ideal fan arrangement, which can have a dramatic impact on the overall thermal performance of a design.

Industry-specific tools—specifically designed for mechanical engineers who develop enclosures for electronic components—are easy to use and provide exceptional simulation power. These include Joule heating, which calculates the steady-state direct electric current in electroconductive solids and is automatically included in heat transfer calculations; two-resistor component models, which improve the accuracy of results using a JEDEC-approved standard; heat pipes, which offer a simple approach for modeling this technique for providing cooling in space-constrained or conduction-cooled designs; PCB generators, which provide a simple, standard approach to determining the physical properties of multilayer PCBs; and an engineering database, which includes a library of interface materials, fans, IC packages, TECs, and two-resistor components.



## Simulations tailored to HVAC

You can save time simulating fluid flows related to heating, ventilation, and air conditioning applications with the SolidWorks Flow Simulation HVAC Module. With this powerful CAD-integrated tool, you can evaluate how the movement of air and gases within a room or structure influences temperature distribution and comfort parameters, such as the “predicted mean vote” (PMV) and the “predicted percent dissatisfied” (PPD), enabling you to optimize airflow and control ambient temperature in working and living environments.

The HVAC Module lets you tackle the difficult challenges related to designing efficient heating and cooling systems for massive facilities, such as arenas, theaters, and shopping malls.

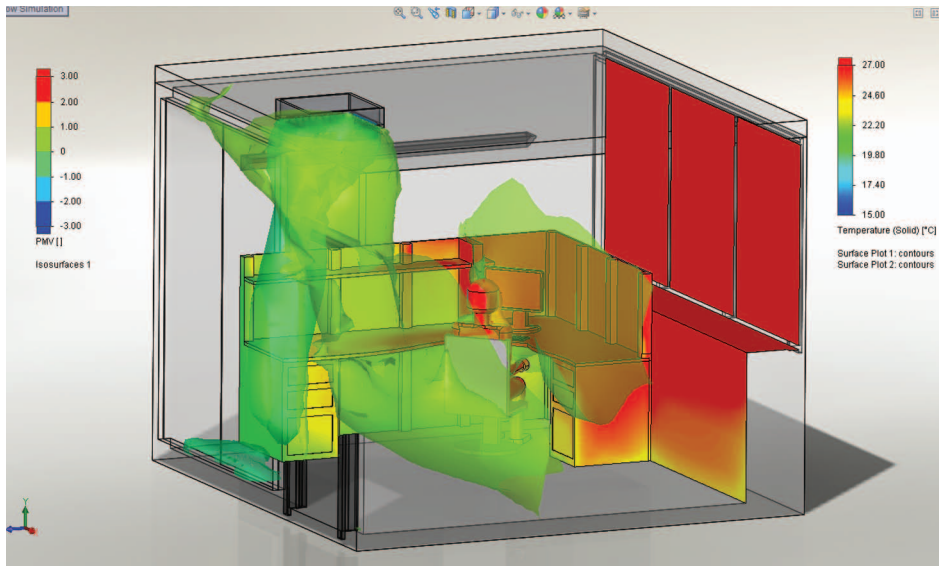

With the SolidWorks Flow Simulation HVAC Module, designers can fully assess the thermal environment created in an occupied zone by heating and cooling systems, including the calculation of comfort parameters.

With this module, you can manage airflow within a large-scale environment, ensuring maintenance of the optimum temperature for the number of people allowed; and validate the thermal behavior of products within a particular setting, going beyond basic airflow studies to confirm thermal comfort.

This module also contains industry-specific tools developed just for engineers who are tasked with developing large HVAC systems. You will have access to the following easy-to-use, yet powerful simulation tools: advanced radiation modeling, which lets you simulate the effects of thermal radiation from the sun and understand the impact of material choices on heating and cooling; an engineering database, which includes a library of building materials; and the calculation of comfort parameters, which allow you to identify the PMV or PPD, two important comfort parameters that help you identify and resolve problem areas before the HVAC system is built and implemented.

## Streamline solutions to heat transfer problems with SolidWorks Flow Simulation

Heat transfer problems are rapidly becoming ubiquitous, and efficiently solving these challenges has become a critical factor for success in an increasingly competitive marketplace. In this environment, manufacturers that leverage flow simulation technology will outpace those that continue to rely on physical prototyping because they simply can resolve heat transfer issues more quickly, introduce more reliable products faster and at lower cost, and develop the industry innovations that are so important to competing successfully over the long run.

Whether you are developing electronic devices, consumer products, or HVAC systems, SolidWorks Flow Simulation software can help you streamline how you handle heat transfer concerns. With easy-to-use, CAD-integrated, and industry-specific tools, you will gain understanding and knowledge about thermal management issues early in the design process, allowing you to improve design performance; reduce prototyping costs; and bring innovative, high-quality products to market faster than the competition.

To learn more about how SolidWorks Flow Simulation solutions can help you efficiently address heat transfer challenges and develop better products, visit [www.solidworks.com](http://www.solidworks.com), or call 1 800 693 9000 or 1 781 810 5011.

---

With an integrated 3D development platform like SolidWorks, you can begin your trip into the future of process and plant design and open up new avenues of productivity, efficiency, and growth.

---

---

Dassault Systèmes  
SolidWorks Corp.  
175 Wyman Street  
Waltham, MA 02451 USA  
Phone: 1 800 693 9000  
Outside the US: +1 781 810 5011  
Email: [info@solidworks.com](mailto:info@solidworks.com)  
[www.solidworks.com](http://www.solidworks.com)

